

Reference Dimensions of Mounting Holes and Vent Opening (unit: mm)

Inlet side, Outlet side

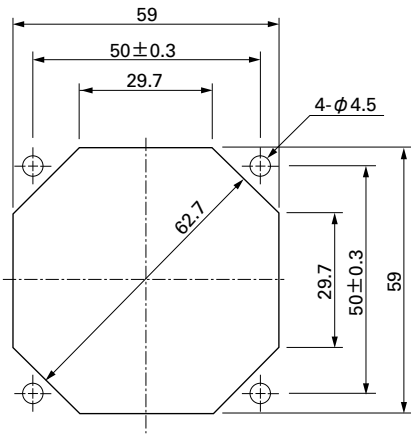

Options (unit: mm)

Finger Guards

Model : 109-139E Surface treatment : Nickel-chrome plating (silver)
 : 109-139H : Cation electropainting (black)

Color

Inlet side, Outlet side

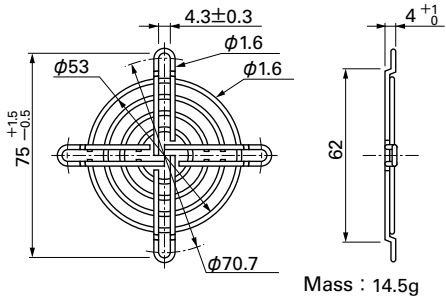

Resin Finger Guards

Model : 109-1003G

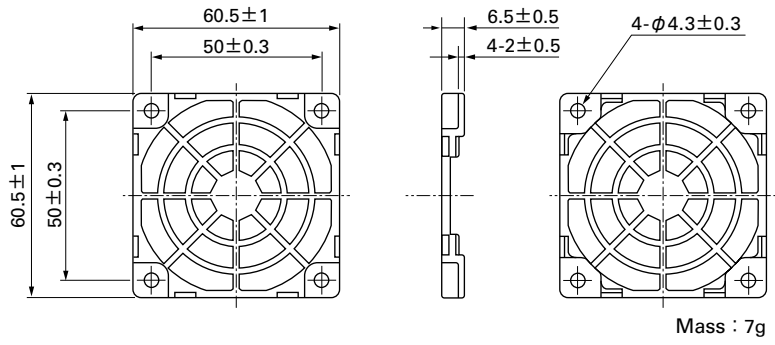

60mm sq.

San Ace 60W

60×60×25mm [Mass : 120g]

Airflow - Static Pressure Characteristics

PWM Duty Cycle

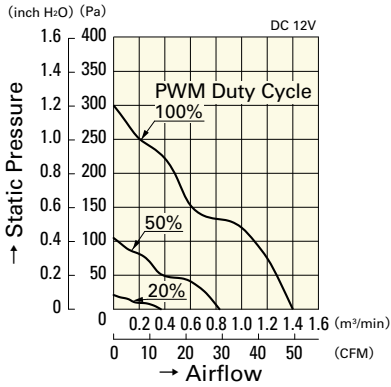

9WL0612P4S001

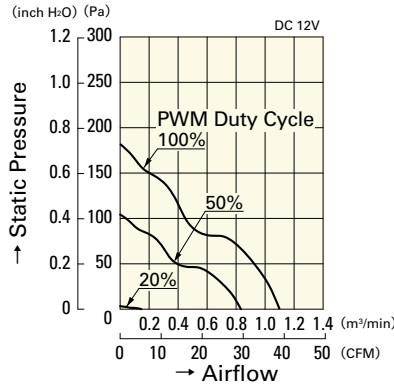

9WL0612P4J001

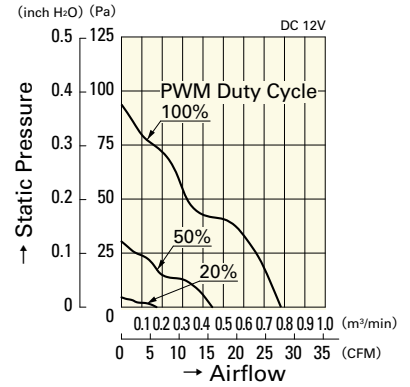

9WL0612P4H001

Operating Voltage Range

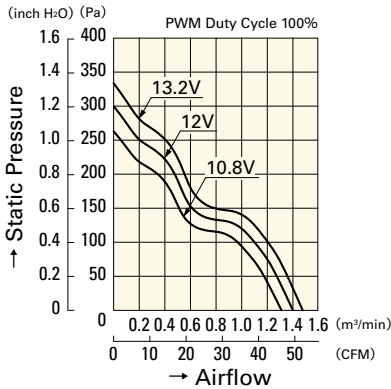

9WL0612P4S001

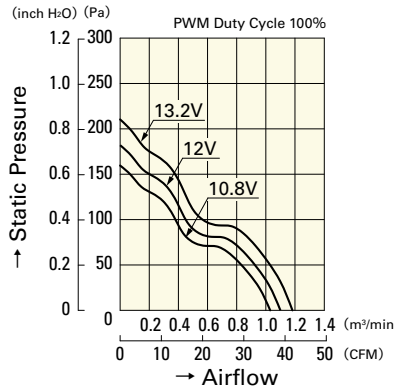

9WL0612P4J001

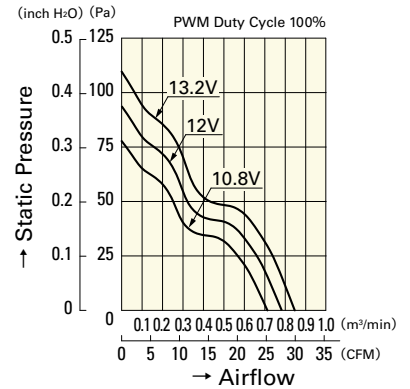

9WL0612P4H001

PWM Duty - Speed Characteristics Example

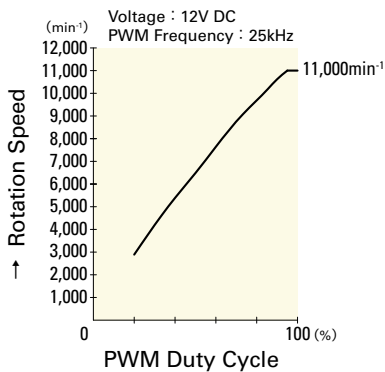

9WL0612P4S001

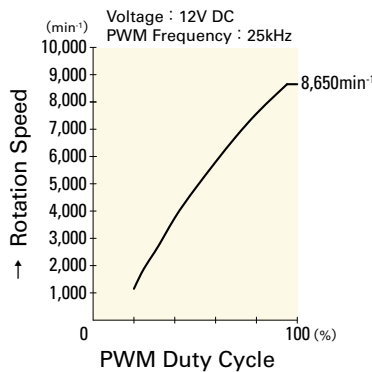

9WL0612P4J001

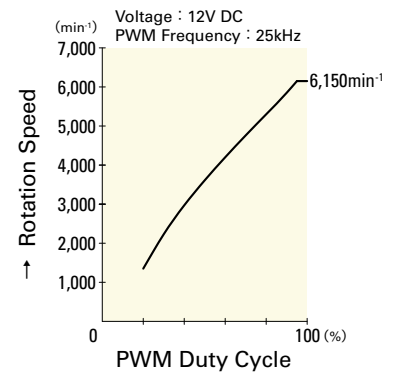

9WL0612P4H001

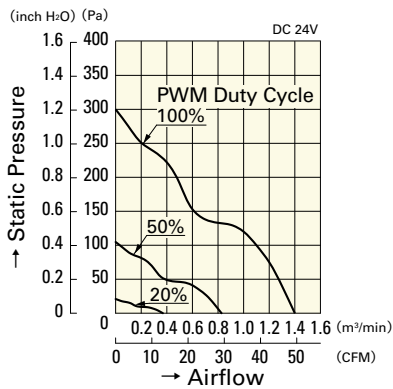

9WL0624P4S001

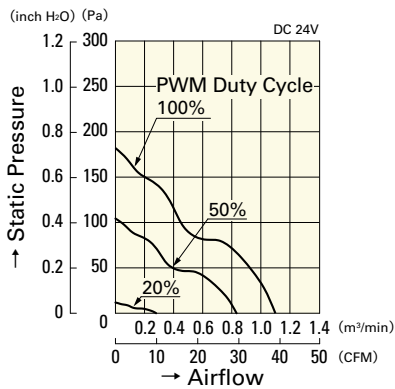

9WL0624P4J001

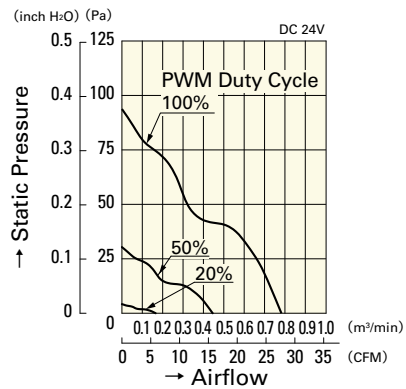

9WL0624P4H001

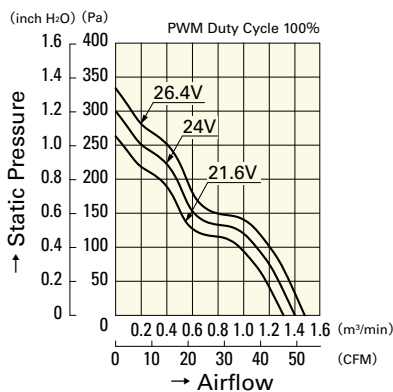

9WL0624P4S001

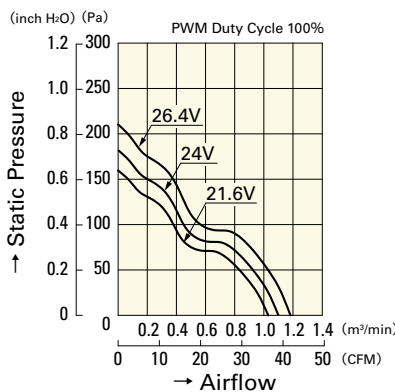

9WL0624P4J001

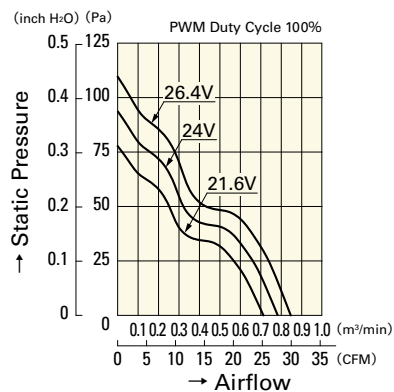

9WL0624P4H001

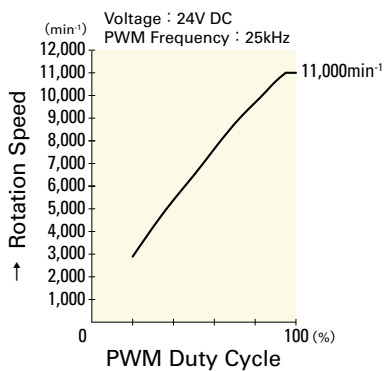

9WL0624P4S001

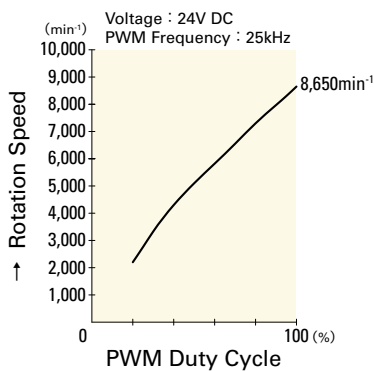

9WL0624P4J001

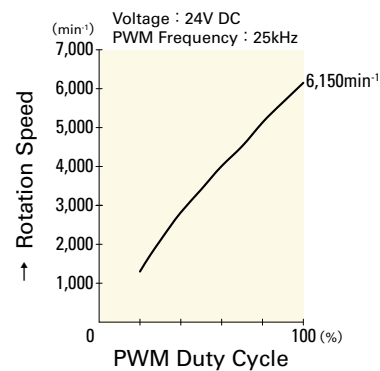

9WL0624P4H001