

Reference Diagram for Mounting

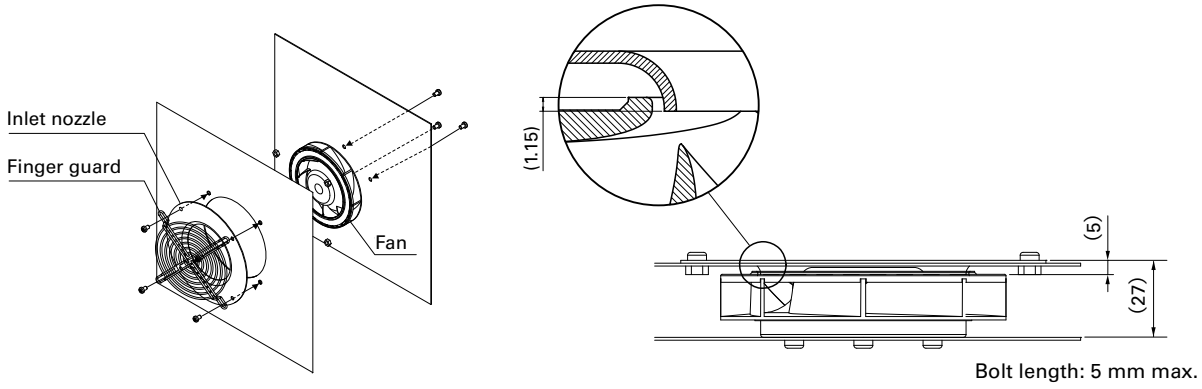

Airflow - Static Pressure Characteristics

PWM Duty Cycle

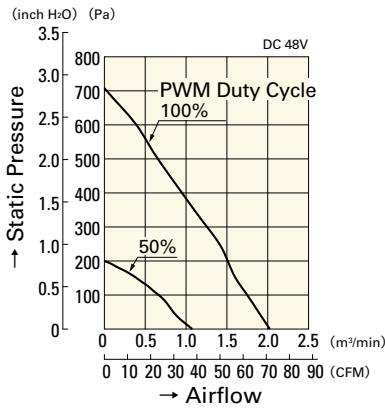

9W1TM48P4G01

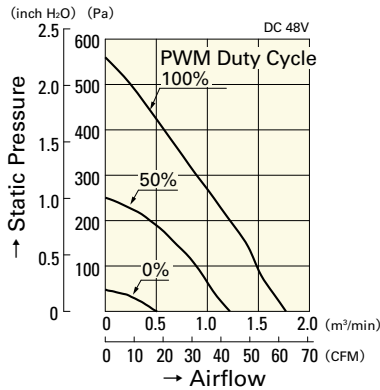

9W1TM48P4H01

Operating Voltage Range

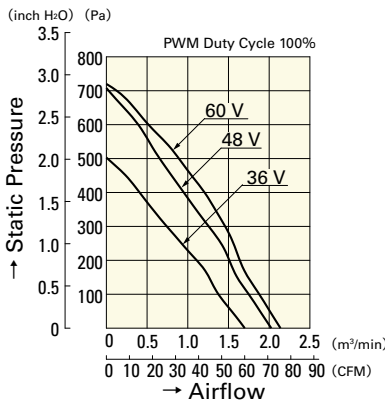

9W1TM48P4G01

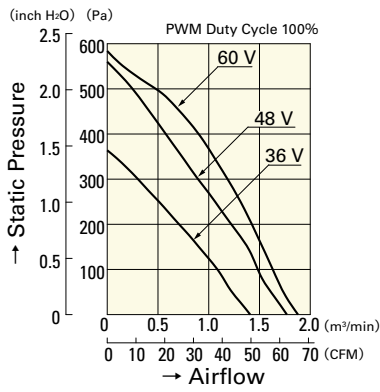

9W1TM48P4H01

PWM Duty - Speed Characteristics Example

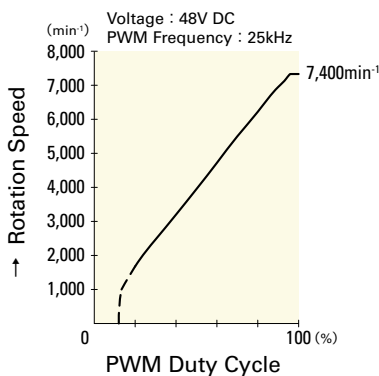

9W1TM48P4G01

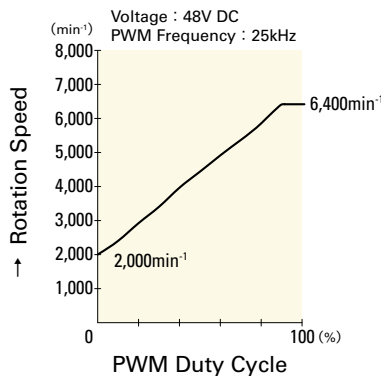

9W1TM48P4H01